



designated according to Article 29 of the Regulation (EU) No 305/2011 and member of EOTA (European Organisation for Technical Assessment, www.eota.eu)

European Technical Assessment

ETA 24/0639
of 26/09/2024

Technical Assessment Body issuing the ETA and designated according to Article 29 of the Regulation (EU) No 305/2011: **UL International (Netherlands) B.V.**

Trade name of the construction product

SOUDAGRAPHITE FR

Product family to which the construction product belongs

Fire Stopping and Sealing Product:
• Penetration Seals

Manufacturer

Soudal N.V.
Everdongengenlaan 18-20
Turnhout,
Belgium

Manufacturing plant(s)

A/003

This European Technical Assessment contains

34 pages including 1 Annex which forms an integral part of this assessment.

This European Technical Assessment is issued in accordance with regulation (EU) No 305/2011, on the basis of

EAD 350454-00-1104, September 2017.

Translations of this European Technical Assessment in other languages shall fully correspond to the original issued document and should be identified as such.

Communication of this European Technical Assessment, including transmission by electronic means, shall be in full. However, partial reproduction may be made, with the written consent of the issuing Technical Assessment Body. Any partial reproduction has to be identified as such.

Table of Contents

I.	SPECIFIC PARTS OF THE EUROPEAN TECHNICAL ASSESSMENT	3
1	Technical description of the product	3
2	Specification of the intended uses of the product in accordance with the applicable European Assessment Document (Hereinafter EAD): EAD 350454-00-1104: 2017.....	3
3	Performance of the product and references to the methods used for its assessment	5
4	ASSESSMENT AND VERIFICATION OF CONSTANCY OF PERFORMANCE (HEREINAFTER AVCP) SYSTEM APPLIED, WITH REFERENCE TO ITS LEGAL BASE	6
5	Technical details necessary for the implementation of the AVCP system, as provided for in the applicable EAD	6
6	Issued on:.....	7
	ANNEX A – Resistance to Fire Classification – SOUDAGRAPHITE FR.....	8
A.1	Flexible or rigid wall constructions with wall thickness of minimum 100 mm	8
A.1.1	Penetration seals, in drywalls* and concrete/masonry walls	8
A.1.2	Penetration seals with no backing material, in drywalls and concrete/masonry walls	11
A.1.3	Penetration seals in drywalls and concrete/masonry walls	13
A.2	Rigid walls constructions with wall thickness of minimum 150 mm	15
A.2.1	Penetration seals for pipes, in concrete/masonry walls	15
A.2.2	Penetration seals for cables, in concrete/masonry walls	16
A.2.3	Penetration seals for pipes, in concrete/masonry walls	17
A.2.4	Penetration seals for pipes, in concrete/masonry walls	18
A.3	Timber wall constructions with wall thickness of minimum 100 mm.....	20
A.3.1	Pipe penetration seals, in timber walls	20
A.4	Rigid floor constructions with floor thickness of minimum 150 mm.....	23
A.4.1	Penetration seals, surface mounted in concrete floors	23
A.4.2	Penetration seals, surface mounted in concrete floors	26
A.4.3	Penetration seals, surfaces mounted in concrete floors	27
A.4.4	Penetration seals, surface mounted in concrete floors	29
A.5	Timber floor constructions with floor thickness of minimum 150 mm	31
A.5.1	Pipe penetration seals, in timber floors	31
	ANNEX B – Air Permeability – SOUDAGRAPHITE FR.....	34

I. SPECIFIC PARTS OF THE EUROPEAN TECHNICAL ASSESSMENT

1 Technical description of the product

- 1) SOUDAGRAPHITE FR is a sealant and pipe closure device used to form penetration seals where insulated metallic pipes, combustible pipes, combustible cable conduits and cables penetrate walls and floors.
- 2) The SOUDAGRAPHITE FR is supplied in liquid form contained within 310 & 380 ml cartridges and 600 ml foil packs. The sealant is gunned into the aperture in the separating element and around the service or services, to a specified depth utilising mineral fibre insulation backing material.
- 3) The applicant has submitted a written declaration that the product and/or constituents of the product contains no substances which have been classified as dangerous according to Directive 67/548/EEC and Regulation (EC) No. 1272/2008 and listed in the 'indicative list on dangerous substances' of the EGDS – taking into account the installation conditions of the construction product and the release scenarios resulting from there.

In addition to the specific clauses relating to dangerous substances contained in this European Technical Assessment, there may be other requirements applicable to the products falling within its scope (e.g. transposed European legislation and national laws, regulations and administrative provisions). In order to meet the provisions of the Construction Products Regulation, these requirements need also to be complied with, when and where they apply.

- 4) The use category of SOUDAGRAPHITE FR in relation to BWR 3 (Hygiene, health and environment) is IA1, S/W2

2 Specification of the intended uses of the product in accordance with the applicable European Assessment Document (Hereinafter EAD): EAD 350454-00-1104: 2017

Detailed information and data is given in Annex A.

The intended use of system SOUDAGRAPHITE FR is to reinstate the fire resistance performance of flexible wall, rigid wall and floor constructions, and timber wall and floor constructions, where they are penetrated by services.

- 1) The specific elements of construction that the system SOUDAGRAPHITE FR may be used to provide a penetration seal in, are as follows:

Flexible walls:	The wall must have a minimum thickness of 100 mm and comprise steel or timber studs* lined on both faces with minimum 2 layers of 12.5 mm thick boards. Flexible wall solutions may also be used in rigid walls, with a minimum density of 350 kg/m ³ .
Timber walls:	The wall must have a minimum thickness of 100 mm and comprise solid wood or cross-laminated timber
Rigid walls:	The wall must have a minimum thickness of 100 mm and comprise concrete, aerated concrete or masonry, with a minimum density of 650 kg/m ³ .
Rigid floors:	The floor must have a minimum thickness of 150 mm and comprise aerated concrete or concrete with a minimum density of 650 kg/m ³ .
Timber floors:	The floor must have a minimum thickness of 150 mm and comprise solid wood or cross-laminated timber.

* no part of the penetration seal may be closer than 100 mm to a stud, the cavity must be closed between the penetration seal and the stud, and minimum 100 mm of insulation of class A1 or A2 according to EN 13501-1 must be provided within the cavity between the penetration seal and the stud.

The supporting construction must be classified in accordance with EN 13501-2 for the required fire resistance period.

Soudal N.V. Fire Protection Systems which involve services penetrating both sides of a flexible wall may also be used in the situation where the services penetrate one side of the wall only and the remaining side of the wall is not penetrated at the same point (i.e. the services continues on the inside of the wall). All fire integrity and thermal insulation ratings for such single-sided penetrations remain the same as for the equivalent double-sided penetration.

Where a backing material is described in Annex A, this can be replaced with SOUDAGRAPHITE FR if the total seal depth is the same or greater.

- 2) The system SOUDAGRAPHITE FR may be used to provide a penetration seal with specific supporting constructions and substrates (for details see Annex A).
- 3) Penetrating services through the system SOUDAGRAPHITE FR may be used in all angles between 90° and 45° in all directions, subject to metallic pipes only.
- 4) Where PVC pipes are mentioned in Annex A, this includes PVC-U, PVC-C and similar if the pipe is according to EN 1329-1, EN 1452-2, EN 1453-1 and EN 1566-1. Where PP pipes are mentioned in Annex A, this includes PP-MV, PP-H, PP-R and similar if the pipe is according to EN 1451-1 or DIN 8077/8078. Where PE pipes are mentioned, this includes PE-LD, PE-MD, PE-HD, PE-X and similar according to EN 1519-1, EN 12201-2 or EN 12666-1, ABS according to EN 1455-1 and pipes made from SAN+PVC according to EN 1565-1.
- 5) The provisions made in this European Technical Assessment are based on an assumed working life of the SOUDAGRAPHITE FR of 25 years, provided that the conditions laid down in the manufacturers datasheet and instructions for the packaging/transport/storage/installation/use/repair are met. The indications given on the working life cannot be interpreted as a guarantee given by the producer, but are to be regarded only as a means for choosing the right products in relation to the expected economically reasonable working life of the works.
- 6) Type Z₂: intended for use at internal conditions with humidity classes other than Z₁, excluding temperatures below 0°C.

3 Performance of the product and references to the methods used for its assessment

Product-type: Sealant/Pipe closure		Intended use: Penetration Seal
Basic requirement for construction work	Basic Requirement	Performance
BWR 2 Safety in case of fire		
EN 13501-1	Reaction to fire	B - s1, d0
EN 13501-2	Resistance to fire	Annex A
BWR 3 Hygiene, health and environment		
EN 1026	Air permeability	Annex B
EAD 350454-00-1104, Annex C	Water permeability	No performance determined
Declaration of manufacturer & EN 16516	Content, emission and/or release of dangerous substances	Use categories: IA1, S/W2 Declaration of manufacturer
BWR 4 Safety in use		
EOTA TR 001:2003	Mechanical resistance and stability	No performance determined
EOTA TR 001:2003	Resistance to impact/movement	No performance determined
EOTA TR 001:2003	Adhesion	No performance determined
EAD 350454-00-1104, Clause 2.2.9	Durability	Z ₂
BWR 5 Protection against noise		
EN 10140-1,2,4,5/ EN ISO 717-1	Airborne sound insulation*	53 (0;-1) dB
BWR 6 Energy economy and heat retention		
EN 12664, EN 12667, EN 12939, EN ISO 8990, EN ISO 6946, EN ISO 14683, EN ISO 10211, EN ISO 10456	Thermal properties	No performance determined
EN ISO 12572, EN 12086, EN ISO 10456	Water vapour permeability	No performance determined

* At 25 mm depth

4 ASSESSMENT AND VERIFICATION OF CONSTANCY OF PERFORMANCE (HEREINAFTER AVCP) SYSTEM APPLIED, WITH REFERENCE TO ITS LEGAL BASE

According to the decision 1999/454/EC – Commission Decision of date 22nd June 1999 on the procedure for attesting the conformity of construction products pursuant to Article 20(2) of Council Directive 89/106/EEC as regards fire stopping, fire sealing and fire protective products, published in the Official Journal of the European Union (OJEU) L178/52 of 14/07/1999, (see <https://eur-lex.europa.eu/oj/direct-access.html>) of the European Commission¹, as amended, the system(s) of assessment and verification of constancy of performance (see Annex V to Regulation (EU) No 305/2011) given in the following table(s) applies (apply).

Product(s)	Intended use(s)	Level(s) or class(es)	System(s)
Fire stopping and Fire Sealing Products	For fire compartmentation and/or fire protection or fire performance	Any	1

5 Technical details necessary for the implementation of the AVCP system, as provided for in the applicable EAD

Tasks of the manufacturer:

Factory production control

The manufacturer shall exercise permanent internal control of production. All the elements, requirements and provisions adopted by the manufacturer shall be documented in a systematic manner in the form of written policies and procedures, including records of results performed. This production control system shall ensure that the product is in conformity with this European Technical Assessment.

The manufacturer may only use initial / raw / constituent materials stated in the technical documentation of this European Technical Assessment.

The factory production control shall be in accordance with the Control Plan of 25th June 2024 relating to the European Technical Assessment ETA 24/0639 issued on 26/09/2024 which is part of the technical documentation of this European Technical Assessment. The "Control Plan" is laid down in the context of the factory production control system operated by the manufacturer and deposited at UL International (Netherlands) B.V.

The results of factory production control shall be recorded and evaluated in accordance with the provisions of the Control Plan.

¹ Official Journal of the European Communities L178/52 of 14/7/1999

Other tasks of the manufacturer:

Additional information

The manufacturer shall provide a technical data sheet and an installation instruction with the following minimum information:

(a) Technical data sheet:

- Field of application:
- Building elements for which the penetration seal is suitable, type and properties of the building elements like minimum thickness, density, and - in case of lightweight constructions – the construction requirements.
- Limits in size, minimum thickness etc. of the penetration seal
- Construction of the penetration seal including the necessary components and additional products (e.g. backfilling material) with clear indication whether they are generic or specific.
- Services which the penetration seal is suitable, type and properties of the services like material, diameter, thickness etc. in case of pipes including insulation materials; necessary/allowed supports/fixings (e.g. pipe trays)

(b) Installation instruction:

- Steps to be followed
- Procedure in case of retrofitting
- Stipulations on maintenance, repair and replacement

6 Issued on:

26 September 2024

Report by:



D. Yates
Staff Engineer
Built Environment

Verified by:



C. Sweeney
Project Engineer
Built Environment

Validated by:



Erik Teubler
Head of TAB
Built Environment

For and on behalf of UL International (Netherlands) B.V.

ANNEX A – Resistance to Fire Classification – SOUDAGRAPHITE FR

A.1 Flexible or rigid wall constructions with wall thickness of minimum 100 mm

A.1.1 Penetration seals, in drywalls* and concrete/masonry walls

Penetration Seal: Combustible pipes sealed with SOUDAGRAPHITE FR, minimum 25 mm deep to both sides of the wall backed with Stonewool (minimum 35kg/m³ density), minimum 25 mm deep. Minimum separation between penetration seals of 30 mm (a2).

Construction details:

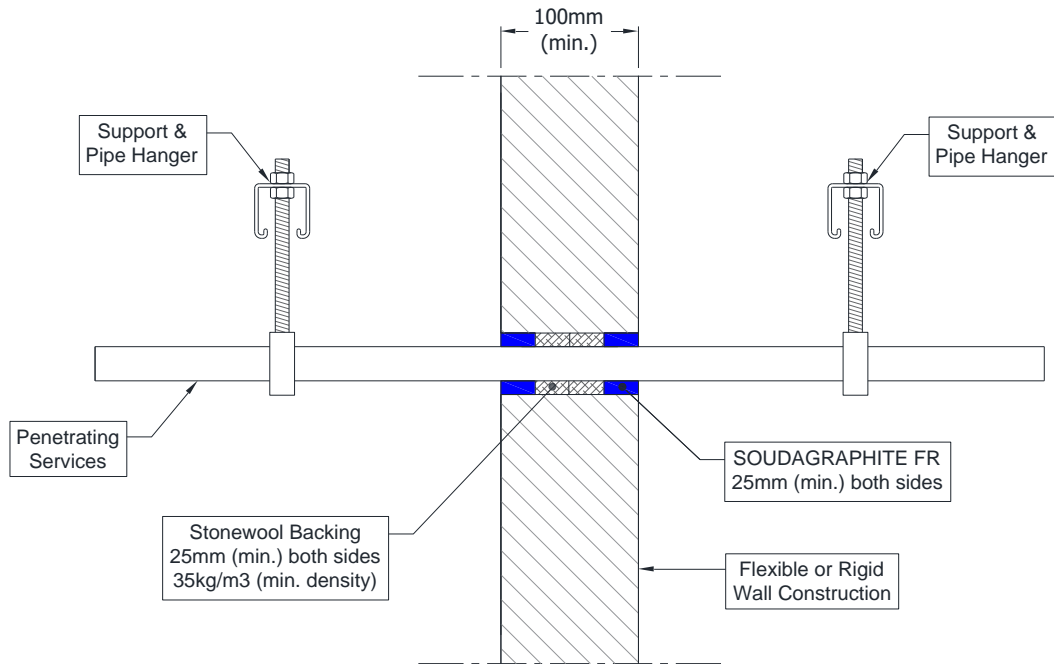

Configuration 1:

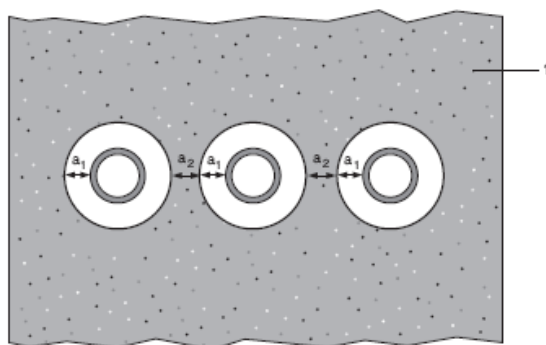

Configuration 2:

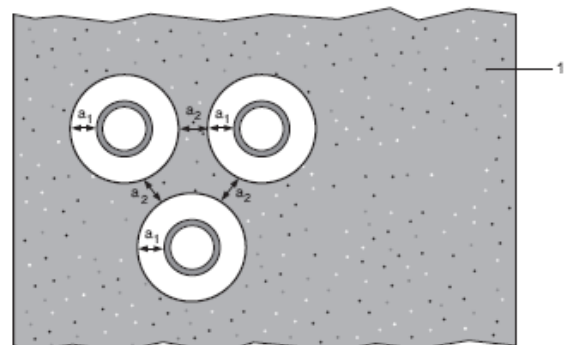

Key

1 Supporting construction

a₁ Pipe / edge of seal separation (annular space)

a₂ Separation between penetration seals

* Partition wall must incorporate a core insulation as support for the backing material.

A.1.1.1

Services	Seal & Backing width (a1)	Permitted configuration for seal separation	Classification
PVC-U pipe according to EN 1329-1, EN 1452-2 and EN 1453-1, PVC-C according to EN 1566-1			
Diameter 40 mm, wall thickness 1.9 – 3.7 mm to diameter 110 mm, wall thickness 2.7-6.6 mm *	10-30 mm	1 & 2	EI 120 U/C, EI 120 C/C
PE pipe according to EN 1519-1, EN 12201-2 and EN 12006-1, ABS according to EN 1455-1 and pipes made from SAN+PVC according to EN 1565-1			
Diameter 40 mm, wall thickness 2.4-3.7 mm	10-30 mm	1 & 2	EI 120 U/C, EI 120 C/C
Diameter 40, wall thickness 2.4-3.7 mm to diameter 110 mm, wall thickness 4.3-10 mm *		1 & 2	EI 60 U/C, EI 60 C/C
Diameter 110 mm, wall thickness 4.3-10 mm		1	E 120 U/C, E 120 C/C EI 90 U/C, EI 90 C/C
PP pipe according to EN 1852-1: 2009 or DIN8077/8078			
Diameter 110 mm, wall thickness 6.6 mm	30 mm	1 & 2	EI 120 U/C, EI 120 C/C
Diameter 40 mm, wall thickness 1.8 -5.5 mm	10 mm	1 & 2	EI 90 U/C

*See below graph for interpolation pipe sizes

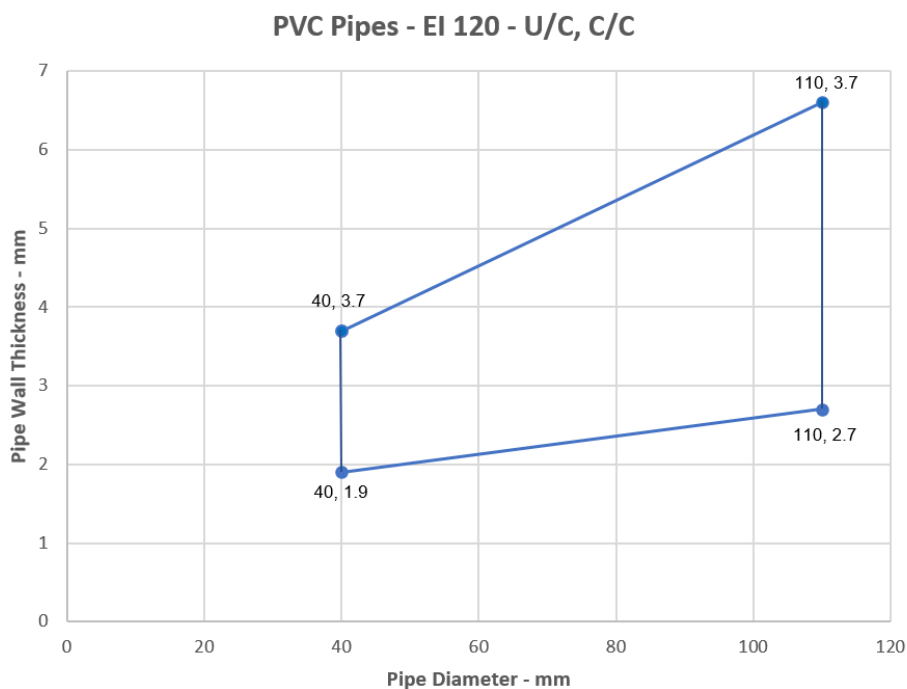

PE Pipes - EI 60 - U/C, C/C

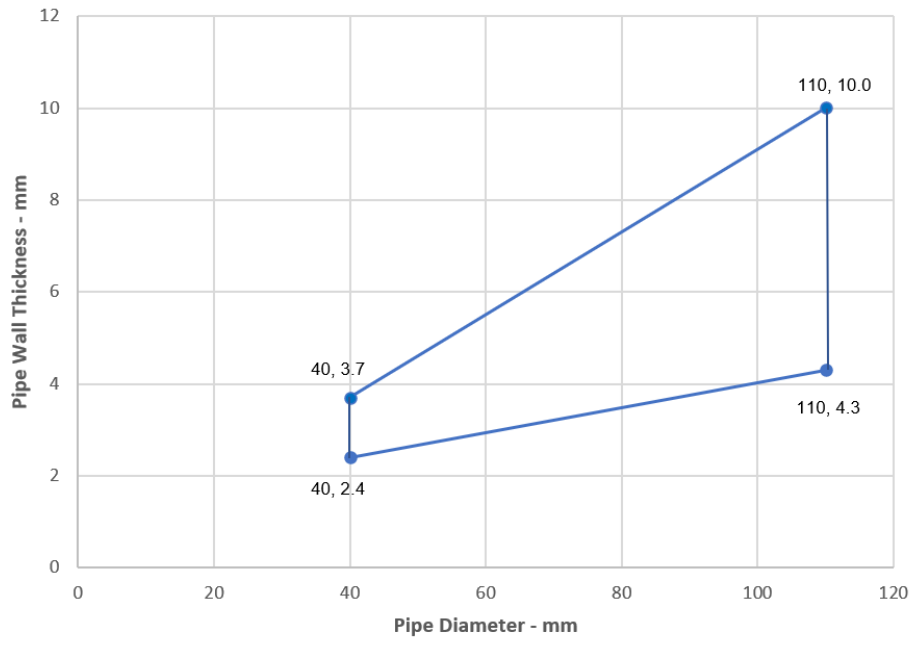

A.1.2 Penetration seals with no backing material, in drywalls and concrete/masonry walls

Penetration Seal: Combustible cable conduit or combustible pipes sealed with SOUDAGRAPHITE FR, minimum 25 mm deep to both sides of the wall without backing material. Minimum separation between penetration seals of 30 mm (a2).

Construction details:

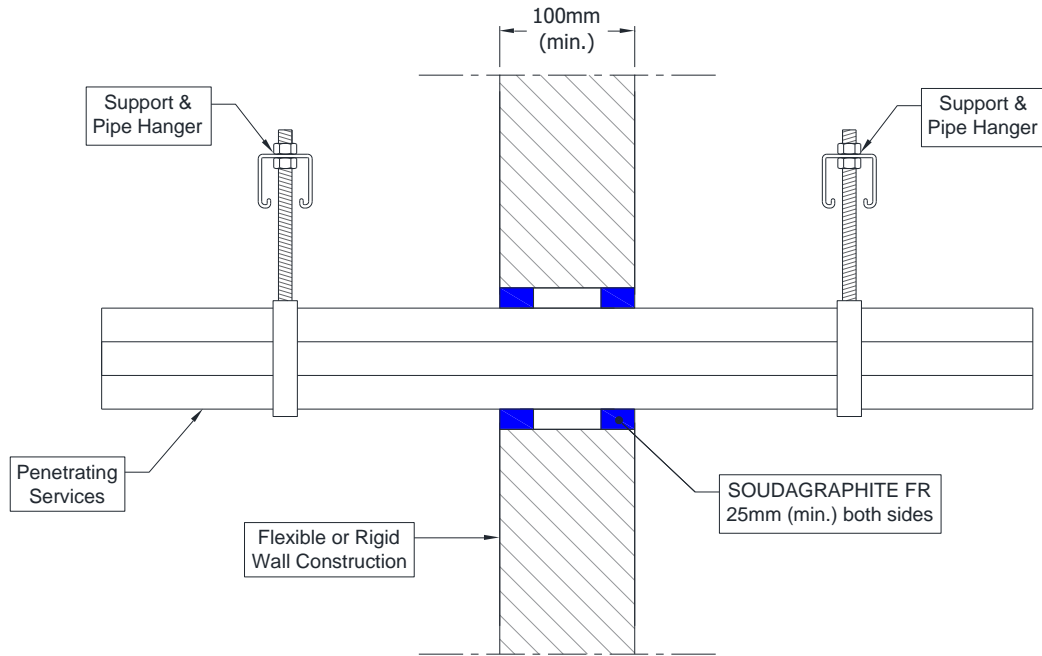

Configuration 1:

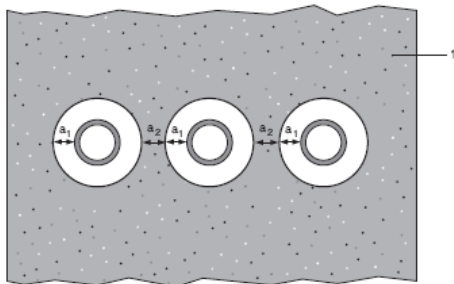

Configuration 2:

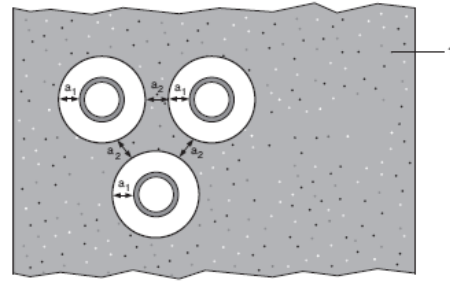

Key

- 1 Supporting construction
- a₁ Pipe / edge of seal separation (annular space)
- a₂ Separation between penetration seals

A.1.2.1

Services	Seal width (a1)	Permitted configuration for seal separation	Classification
PVC-U pipe according to EN 1329-1, EN 1452-2 and EN 1453-1, PVC-C according to EN 1566-1 or PP pipe according to EN 1852-1: 2009 or DIN8077/8078			
Maximum diameter 110 mm, wall thickness 1.9-6.6 mm for PVC pipes, fully or partially filled conduits with cables up to 20mm diameter	10-30 mm	1 & 2	EI 90 U/C
Maximum diameter 110 mm, wall thickness 2.7-6.6 mm for PP pipes, fully or partially filled conduits with cables up to 20mm diameter	10-30 mm	1 & 2	EI 90 U/C
PE pipe according to EN 1519-1, EN 12201-2 and EN 12006-1, ABS according to EN 1455-1 and pipes made from SAN+PVC according to EN 1565-1			
Maximum diameter 110 mm, wall thickness 2.4-10 mm, fully or partially filled conduits with cables up to 20 mm conduit	10-30 mm	1 & 2	EI 60 U/C
PVC-U pipe according to EN 1329-1, EN 1452-2 and EN 1453-1, PVC-C according to EN 1566-1			
Maximum 160 mm diameter, wall thickness 3.2-9.5 mm	10-30 mm	1 & 2	EI 30 U/C
Maximum 160 mm diameter, wall thickness 9.5 mm	10-30 mm	1 & 2	EI 90 U/C
PP pipe according to EN 1852-1: 2009 or DIN8077/8078			
Maximum 110 mm, wall thickness 2.7 mm	10-30 mm	1 & 2	EI 60 C/C
Maximum 110 mm*	10-30 mm	1 & 2	EI 60 U/C

*See below graph for interpolation pipe sizes

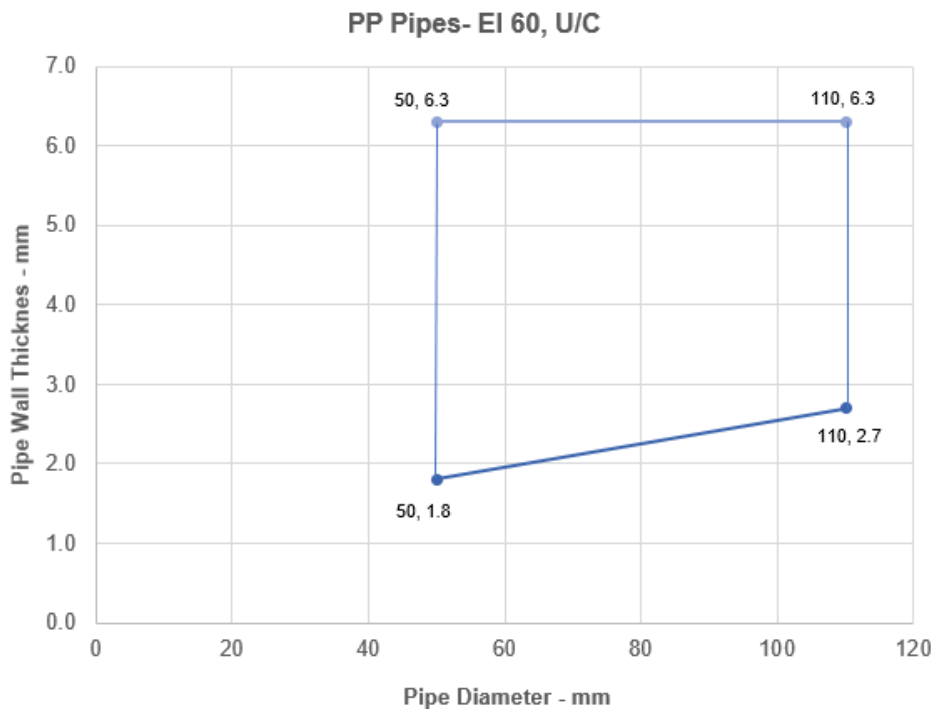

A.1.3 Penetration seals in drywalls and concrete/masonry walls

Penetration Seal: Metallic pipes insulated with Elastomeric insulation, Continuous Sustained (CS), sealed with SOUDAGRAPHITE FR, minimum 25 mm deep to both sides of the wall backed with AES Fibre $\geq 128\text{kg/m}^3$, minimum 25 mm deep. Minimum separation between penetration seals of 30 mm (a₂).

Construction details:

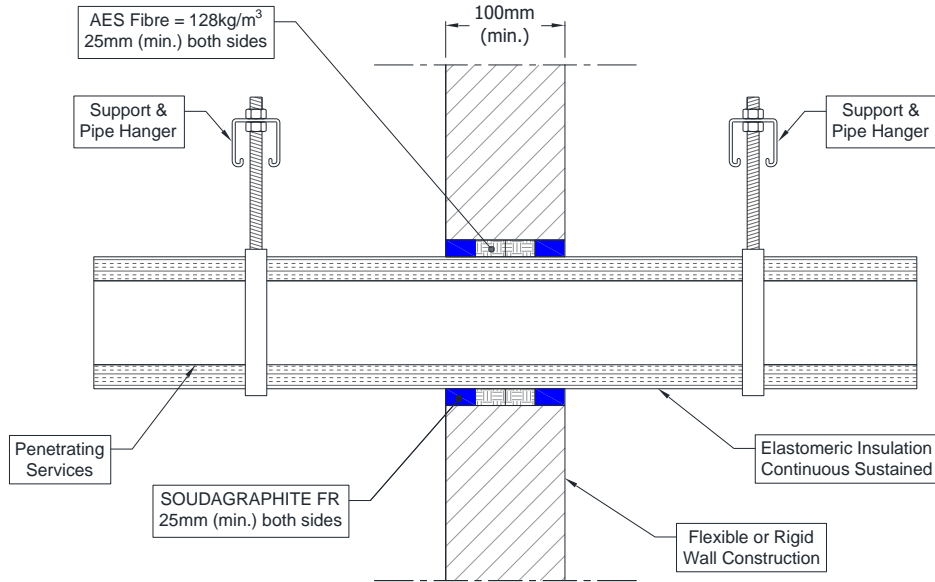

Configuration 1:

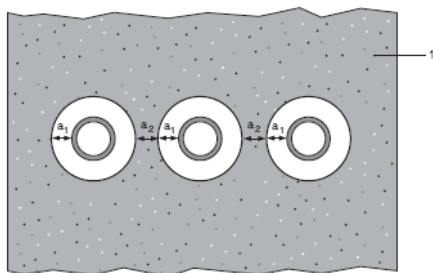

Configuration 2:

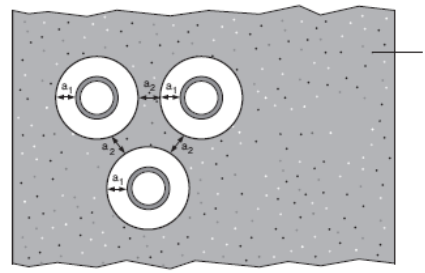

Key

- 1 Supporting construction
- a₁ Pipe / edge of seal separation (annular space)
- a₂ Separation between penetration seals

A.1.3.1

Services	Seal & backing material width (a ₁)	Permitted configuration for seal separation	Insulation CS	Classification
Mild or stainless steel pipe, with Elastomeric insulation minimum class B-s3, d0				
Maximum 15 mm diameter, wall thickness minimum 1.0 mm	10 mm	1 & 2	25-50 mm Elastomeric insulation minimum class B-s3, d0	60 C/C
Maximum 324 mm diameter, wall thickness 1.0-14.2 mm*	10 mm	1 & 2	50 mm Elastomeric insulation minimum class B-s3, d0	EI 60 C/U

*See below graph for interpolation pipe sizes

Insulated Steel Pipes - EI 60 - C/U

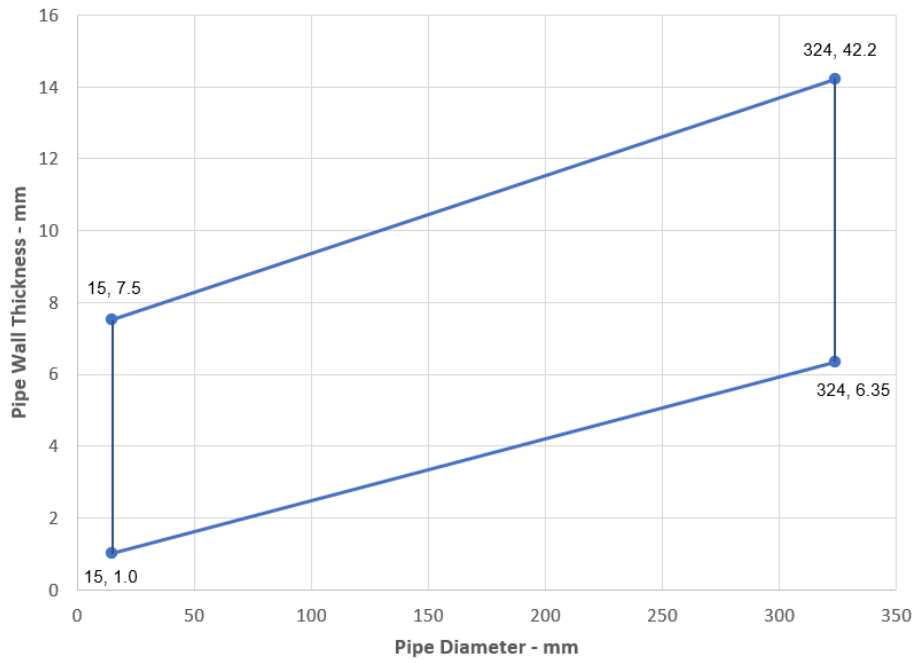

A.2 Rigid walls constructions with wall thickness of minimum 150 mm

A.2.1 Penetration seals for pipes, in concrete/masonry walls

Penetration Seal: Combustible pipes sealed with minimum 40 mm deep SOUDAGRAPHITE FR, to both sides of the wall backed with SOUDAL FIREBOARD 2S, 50 mm thick. Minimum separation between penetration seals of 30 mm.

Construction details:

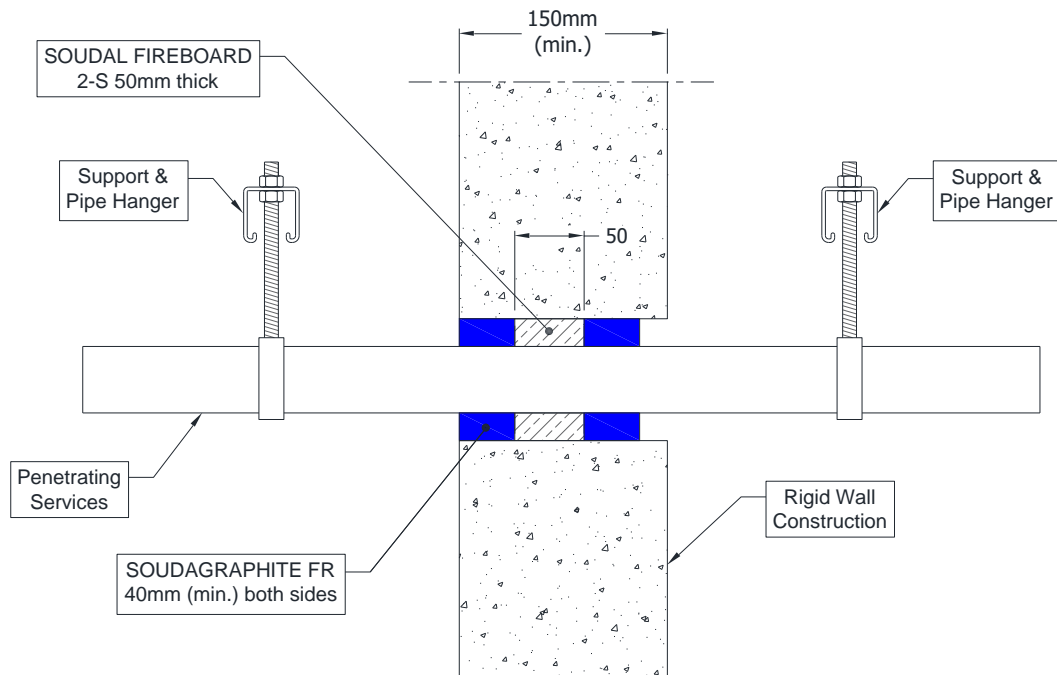

A.2.1.1

Services	Seal & Backing width	Classification
PVC-U pipe according to EN 1329-1, EN 1452-2 and EN 1453-1, PVC-C according to EN 1566-1		
Diameter 48 mm, wall thickness 3.2 mm	17 mm	EI 240 U/C, EI 240 C/C
Diameter 68 mm, wall thickness 2 mm	41 mm	
Diameter 110 mm, wall thickness 3.5 mm	22 mm	
PE pipe according to EN 1519-1, EN 12201-2 and EN 12006-1, ABS according to EN 1455-1 and pipes made from SAN+PVC according to EN 1565-1		
Diameter 32 mm, wall thickness 3.2 mm	25 mm	EI 240 U/C, EI 240 C/C
ABS pipe according to EN 1455-1		
Diameter 36 mm, wall thickness 2.3 mm	23 mm	EI 240 U/C, EI 240 C/C
Diameter 110 mm, wall thickness 3.5 mm	26 mm	

A.2.2 Penetration seals for cables, in concrete/masonry walls

Penetration Seal: Cables sealed with minimum 40 mm deep SOUDAGRAPHITE FR, to both sides of the wall backed with SOUDAL FIREBOARD 2S, 50 mm thick. Minimum separation between penetration seals of 30 mm.

Construction details:

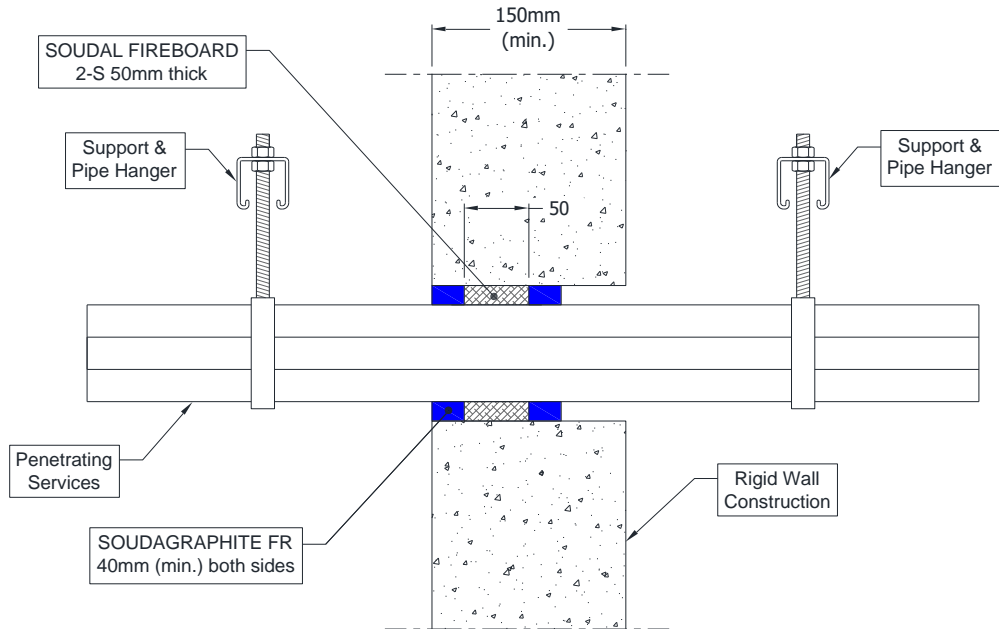

A.2.2.1

Services	Seal size (WxH or diameter)	Classification
150 x 25 mm perforated steel cable tray	Maximum 200 x 100 mm	E 240, EI 180
20 mm diameter, single copper core armoured cable		
Twin/earth cable		
Ø 100 mm bundle of up to 4 no. 20mm diameter, single copper core armoured cable and 12 no. twin/earth cables	Maximum 150 mm Ø	E240, EI 60

A.2.3 Penetration seals for pipes, in concrete/masonry walls

Penetration Seal: Combustible pipes sealed with minimum 35 mm deep SOUDAGRAPHITE FR, to both sides of the wall backed with AES Fibre $\geq 128\text{kg/m}^3$ backing material, minimum 25 mm thick. Minimum separation between penetration seals of 30 mm.

Construction details:

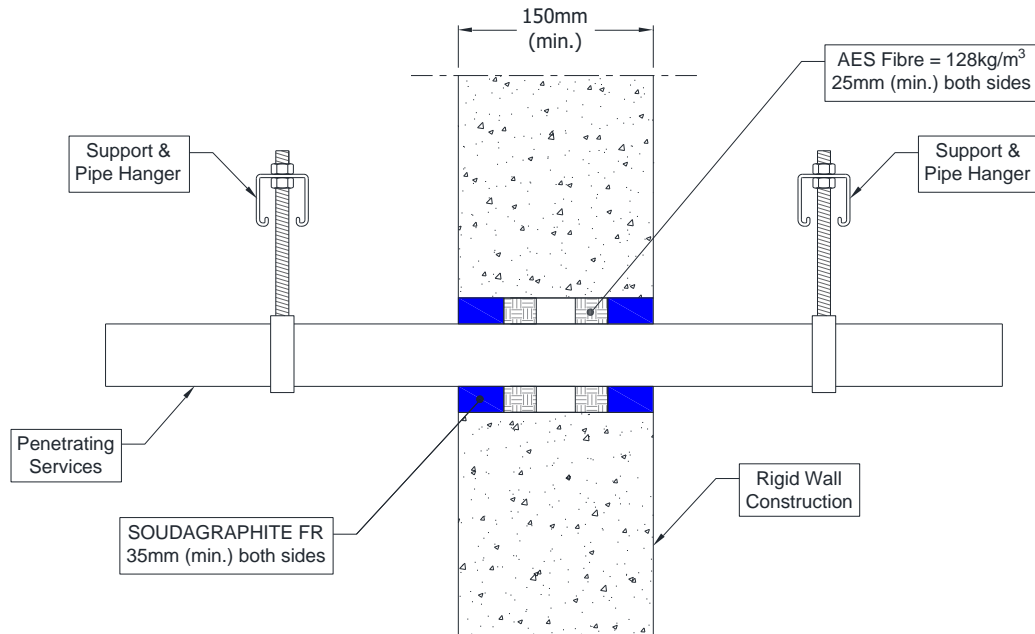

A.2.3.1

Services	Seal & Backing width (a1)	Classification
PVC-U pipe according to EN 1329-1, EN 1452-2 and EN 1453-1, PVC-C according to EN 1566-1		
Maximum 160 mm diameter, wall thickness 4.0-9.5 mm	10-30 mm	EI 90 U/C
Maximum 160 mm diameter, wall thickness 9.5 mm	10-30 mm	E 240, EI 180 U/C
PE pipe according to EN 1519-1, EN 12201-2 and EN 12006-1, ABS according to EN 1455-1 and pipes made from SAN+PVC according to EN 1565-1		
Maximum 160 mm diameter, wall thickness 4.9-9.5mm	10-30 mm	EI 30 U/C
PP pipe according to EN 1852-1: 2009 or DIN8077/8078		
Maximum 160 mm diameter, wall thickness 6.2-9.1 mm	10 mm	EI 30 U/C

A.2.4 Penetration seals for pipes, in concrete/masonry walls

Penetration Seal: Combustible pipes sealed with minimum 25 mm deep SOUDAGRAPHITE FR, to both sides of the wall backed with Stonewool (minimum 35kg/m³ density), minimum 25 mm deep. Minimum separation between penetration seals of 30 mm (a2).

Construction details:

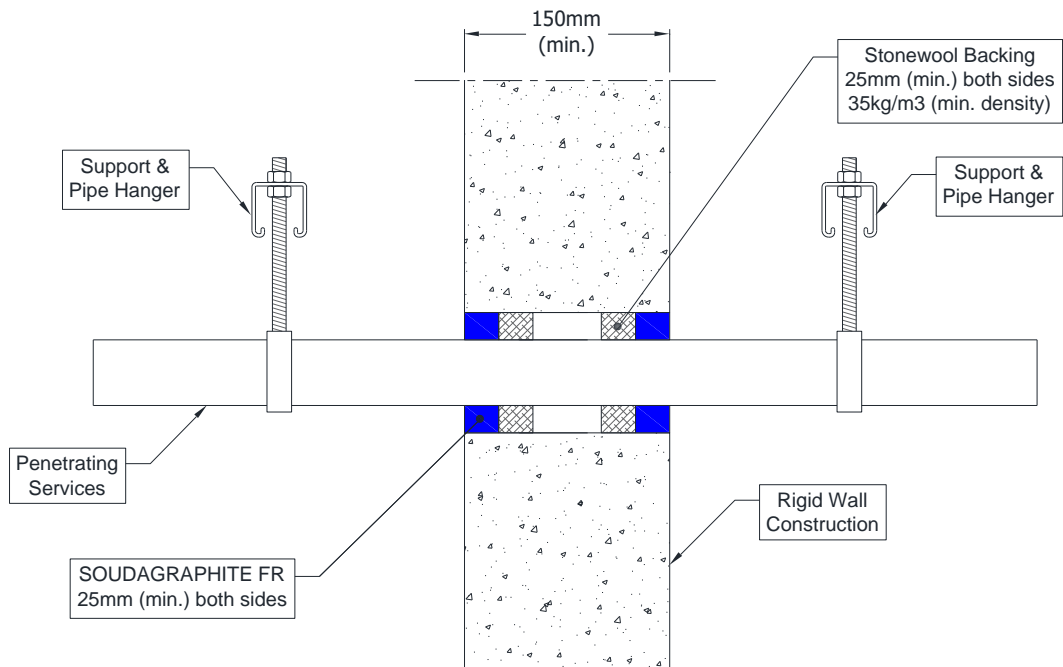

Configuration 1:

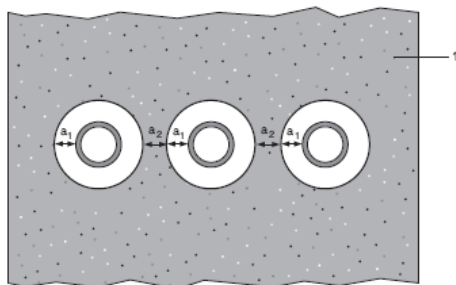

Configuration 2:

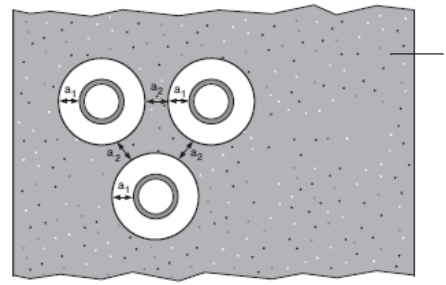

Key

- 1 Supporting construction
- a₁ Pipe / edge of seal separation (annular space)
- a₂ Separation between penetration seals

A.2.4.1

Services	Seal width (a1)	Permitted configuration for seal separation	Classification
PVC pipe			
Diameter 40 mm, wall thickness 1.9 – 3.7 mm to diameter 110 mm, wall thickness 2.7-6.6 mm, partially or fully filled conduits with cables up to 20 mm diameter	10-30 mm	1 & 2	EI 120 U/C
Diameter 110 mm, wall thickness 6.6 mm, fully filled conduits with cables up to 20 mm diameter	10 mm	1 & 2	EI 240 U/C
PE pipe			
Diameter 110 mm, wall thickness 4.2 mm, fully filled conduits with cables up to 20 mm diameter	10 mm	1 & 2	EI 120 U/C
PP pipe			
Diameter 110 mm, wall thickness 3.4 mm, fully filled conduits with cables up to 20 mm diameter	10 mm	1 & 2	EI 120 U/C

A.3 Timber wall constructions with wall thickness of minimum 100 mm

A.3.1 Pipe penetration seals, in timber walls

Penetration Seal: Metallic pipes insulated with Elastomeric insulation minimum class D-s3,d0, Continuous Sustained (CS), sealed with SOUDAGRAPHITE FR, minimum 25 mm deep to both sides of the wall and backed with Stonewool (minimum 33kg/m³ density), minimum 25 mm deep. Minimum separation between penetration seals of 30 mm (a₂).

Construction details:

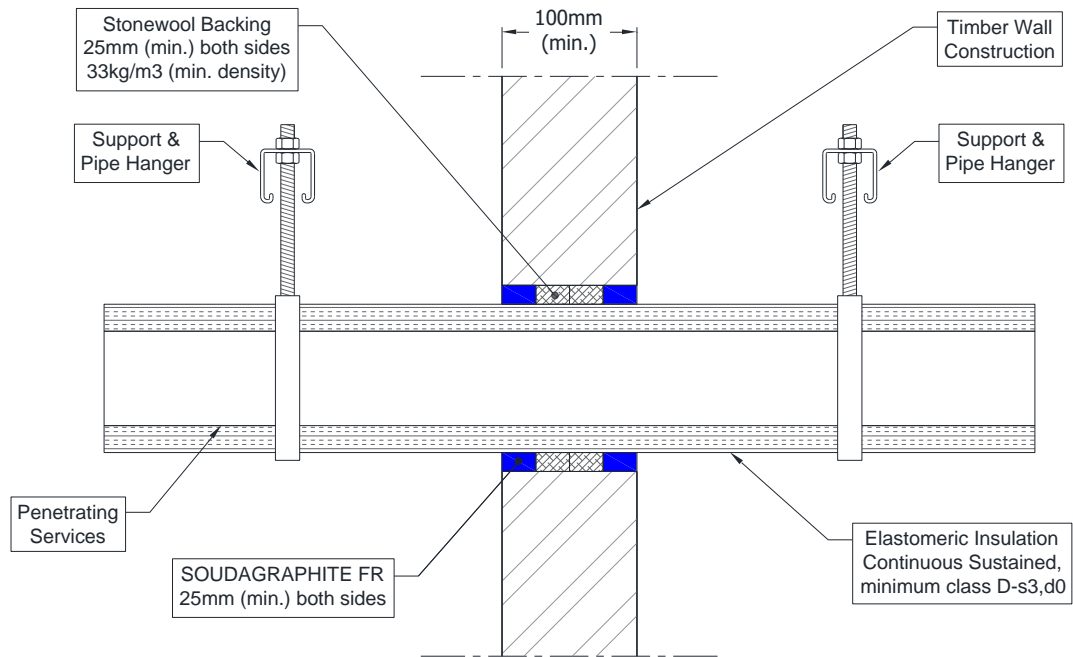

Configuration 1:

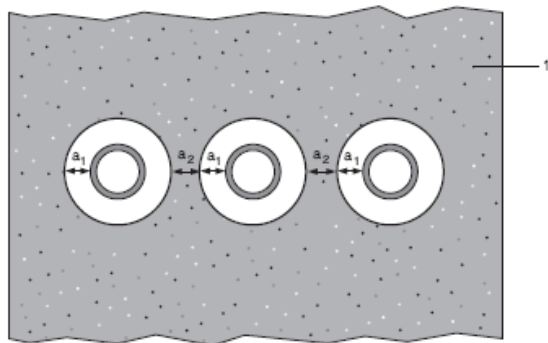

Configuration 2:

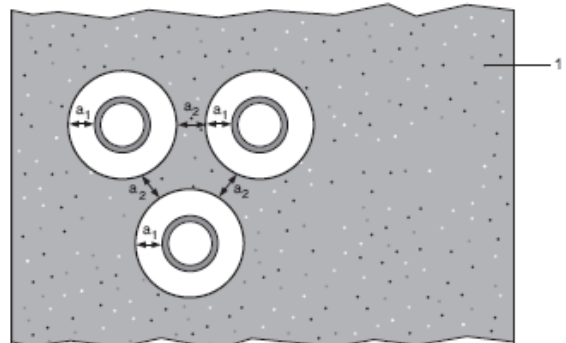

Key

1 Supporting construction

a₁ Pipe / edge of seal separation (annular space)

a₂ Separation between penetration seals

A.3.1.1

Services	Seal & backing material width (a1)	Permitted configuration for seal separation	Insulation CS	Classification
Copper, mild or stainless steel pipe				
Diameter 12 mm, wall thickness 0.7	10 mm	1	13 mm Elastomeric insulation minimum class D-s3, d0	EI 120 C/C
Diameter 12-54 mm, wall thickness*				E 120 C/C, EI 90 C/C
Diameter 12-54 mm, wall thickness*			14-25 mm Elastomeric insulation minimum class D -s3, d0	E 120 C/C, EI 30 C/C
Mild or stainless steel pipe, with Elastomeric insulation minimum class D-s3, d0				
Diameter 12-114 mm, wall thickness*	10 mm	1	13 mm Elastomeric insulation minimum class D -s3, d0	EI 90 C/C
Diameter 12-114 mm, wall thickness*			14-25 mm Elastomeric insulation minimum class D-s3, d0	E 90 C/C, EI 45 C/C
Diameter 114 mm, wall thickness 1.5-14.2			13 mm Elastomeric insulation minimum class D-s3, d0	EI 90 C/U
Diameter 114 mm, wall thickness 1.5-14.2			13-25 mm Elastomeric insulation minimum class D-s3, d0	E 90 C/U, EI 45 C/U
Alupex pipe, with Elastomeric insulation minimum class D-s3, d0				
Diameter 16 mm, wall thickness 2.25	10 mm	1	13 mm Elastomeric insulation minimum class D-s3, d0	EI 120 C/C
Diameter 16-75 mm, wall thickness*				E 120 C/C, EI 45 C/C
Diameter 16-75 mm, wall thickness*			14-24 mm Elastomeric insulation minimum class D-s3, d0	E 90 C/C, EI 45 C/C
Diameter 16-75 mm, wall thickness*			25 mm Elastomeric insulation minimum class D -s3, d0	EI 90 C/C

See below graph for interpolation pipe sizes

Copper or Steel Pipes with Elastomeric Insulation - C/C

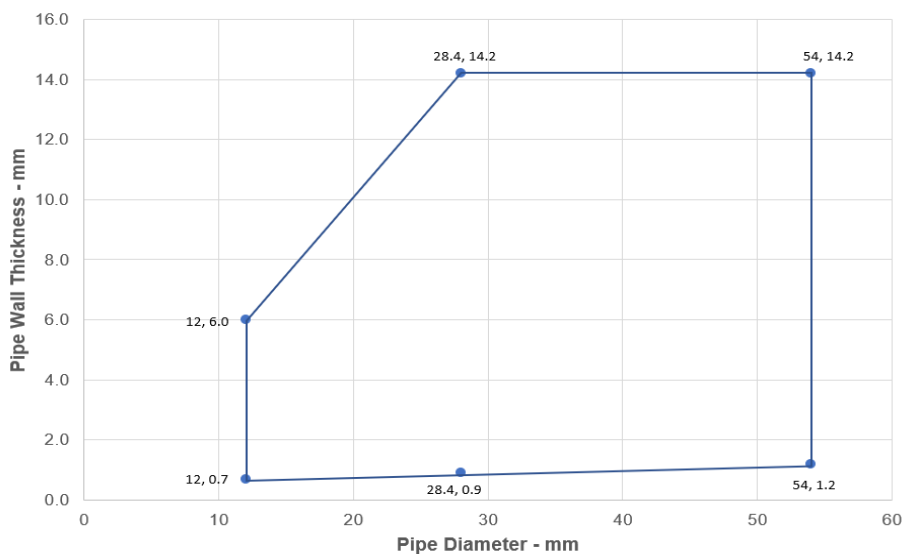

Steel Pipes with Elastomeric Insulation - C/C

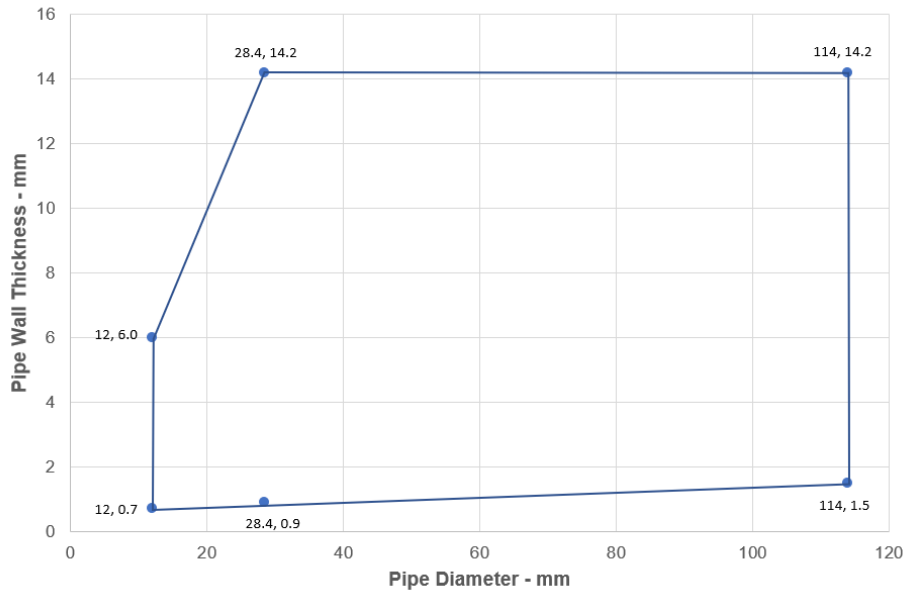

Alupex Pipes with Elastomeric Insulation - C/C

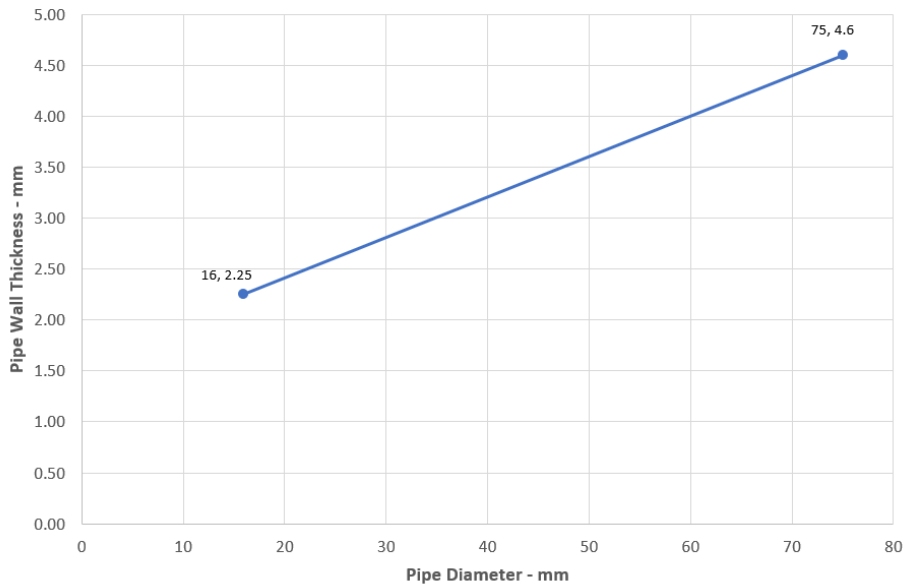

A.4 Rigid floor constructions with floor thickness of minimum 150 mm

A.4.1 Penetration seals, surface mounted in concrete floors

Penetration Seal: Combustible pipes sealed with Soudagraphe FR, to both sides of the floor backed with Stonewool (minimum 35kg/m³ density), minimum 25 mm deep. Minimum separation between penetration seals of 30 mm.

Construction details:

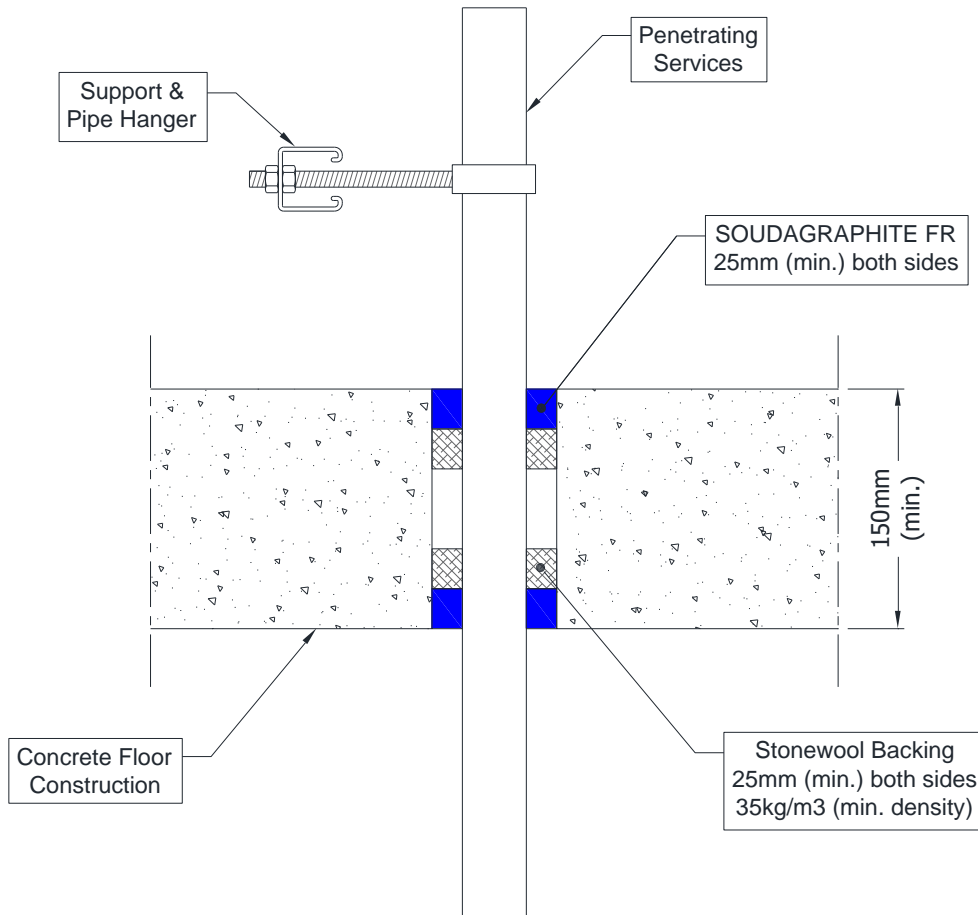

Configuration 1:

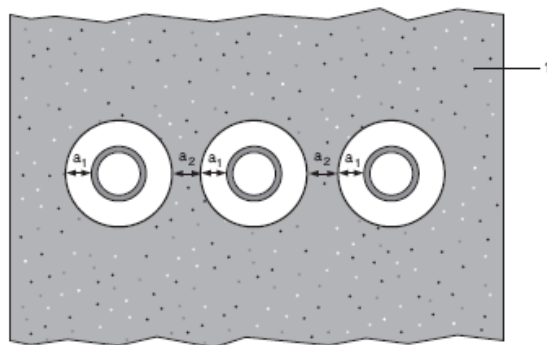

Configuration 2:

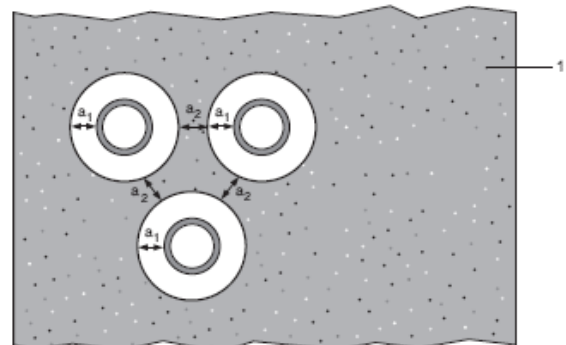

Key

- 1 Supporting construction
- a₁ Pipe / edge of seal separation (annular space)
- a₂ Separation between penetration seals

A.4.1.1

Services	Seal & Backing width	Permitted configuration for seal separation	Classification
PVC-U pipe according to EN 1329-1, EN 1452-2 and EN 1453-1, PVC-C according to EN 1566-1	10-30 mm	1 & 2	EI 240 U/U, EI 240 C/U, EI 240 U/C, EI 240 C/C
Diameter 40 mm, wall thickness 1.8 – 3.7 mm		1 & 2	EI 90 C/U, EI 90 C/C
Diameter 40 mm, wall thickness 1.8 – 3.7 mm to diameter 110 mm, wall thickness 2.7-6.6 mm *	10-30 mm	1 & 2	EI 60 U/U, EI 60 C/U, EI 60 U/C, EI 60 C/C
Diameter 40 mm, wall thickness 2.4-3.7 mm			EI 240 U/C, EI 240 C/C
Diameter 40, wall thickness 2.4-3.7 mm to diameter 110 mm, wall thickness 4.3-10 mm *		1 & 2	EI 60 U/C, EI 60 C/C
Diameter 110 mm, wall thickness 4.3-10 mm		1 & 2	EI 90 U/C, EI 90 C/C
Diameter 110 mm, wall thickness 10 mm			EI 60 U/U, EI 60 C/U, EI 60 U/C, EI 60 C/C

See below graph for interpolation pipe sizes

PVC Pipes - EI 90 - C/U, C/C

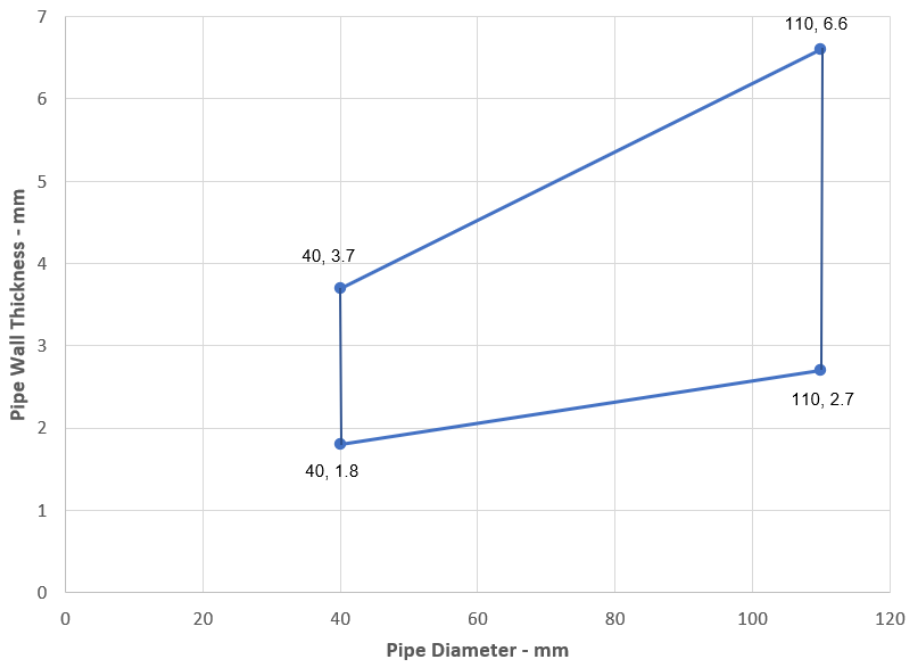

PVC Pipes - EI 90 - C/U, C/C

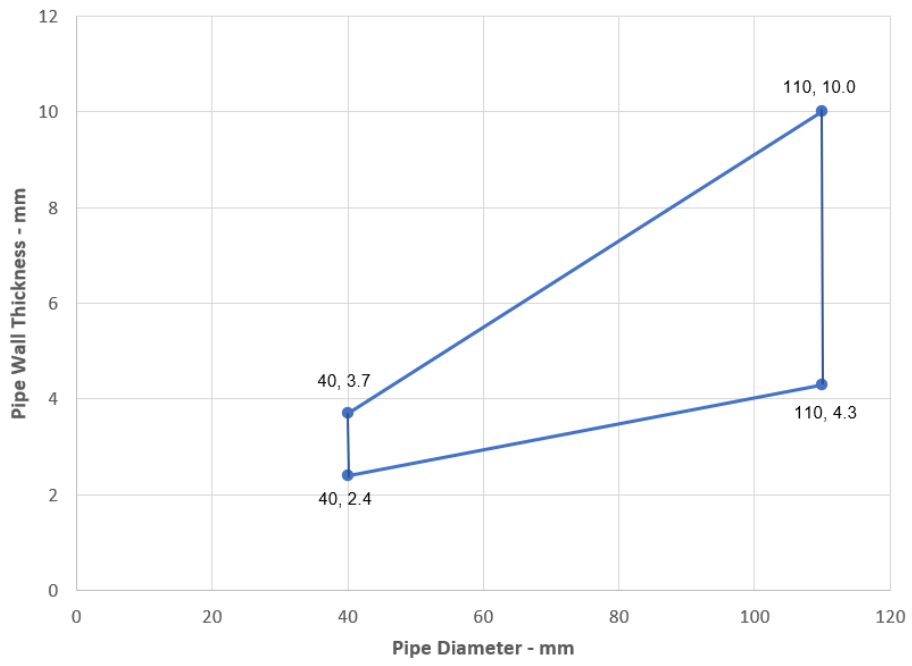

A.4.2 Penetration seals, surface mounted in concrete floors

Penetration Seal: Combustible pipes sealed with SOUDAGRAPHITE FR, minimum 35 mm deep to both sides of the floor backed with AES Fibre $\geq 128\text{kg/m}^3$ Wool (128kg/m^3 density), minimum 25 mm deep. Minimum separation between penetration seals of 30 mm.

Construction details:

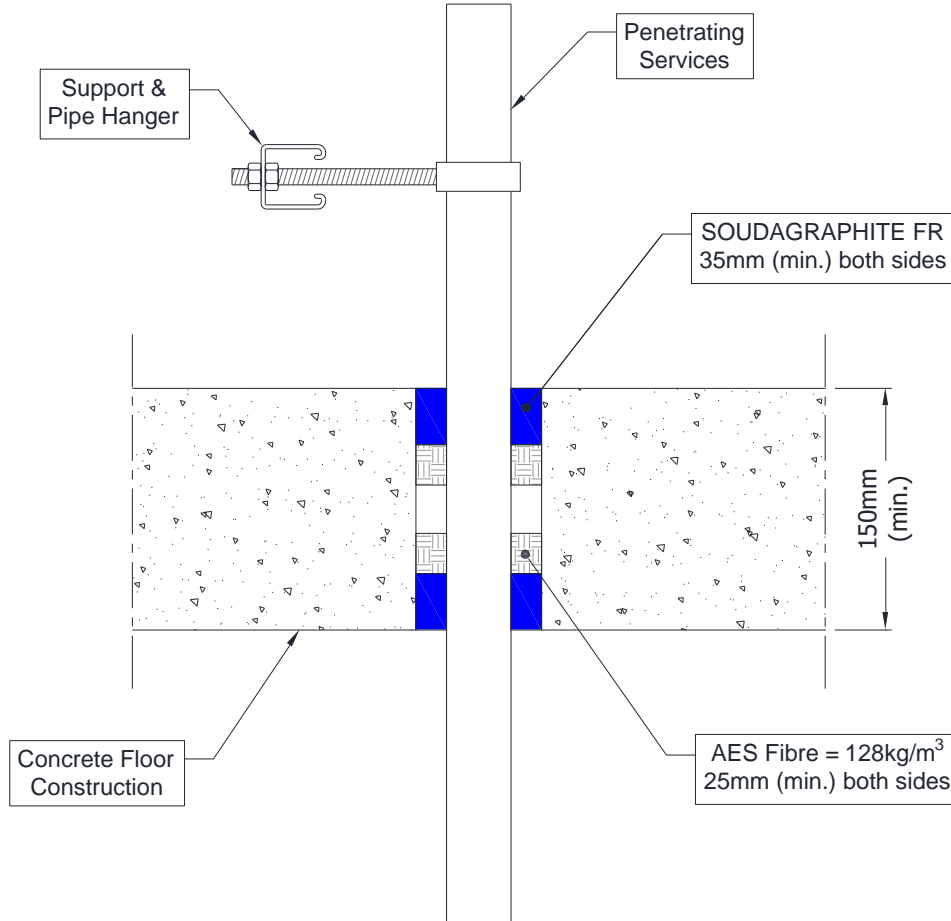

A.4.2.1

Services	Seal & Backing width (a1)	Classification
PVC-U pipe according to EN 1329-1, EN 1452-2 and EN 1453-1, PVC-C according to EN 1566-1		
Maximum 160 mm diameter, wall thickness 4.0-9.5mm	10-30 mm	EI 60 U/C
PE pipe according to EN 1519-1, EN 12201-2 and EN 12006-1, ABS according to EN 1455-1 and pipes made from SAN+PVC according to EN 1565-1		
Maximum 160 mm diameter, wall thickness 4.9-14.6 mm	10-30 mm	EI 30 U/C
Maximum 160 mm diameter, wall thickness 14.6 mm	10-30 mm	EI 60 U/C

A.4.3 Penetration seals, surfaces mounted in concrete floors

Penetration Seal: Combustible pipes sealed with SOUDAGRAPHITE FR, minimum 25 mm deep to both sides of the floor backed with Rock mineral wool (minimum 33kg/m³ density), minimum 25 mm deep. Minimum separation between penetration seals of 30 mm (a2).

Construction details:

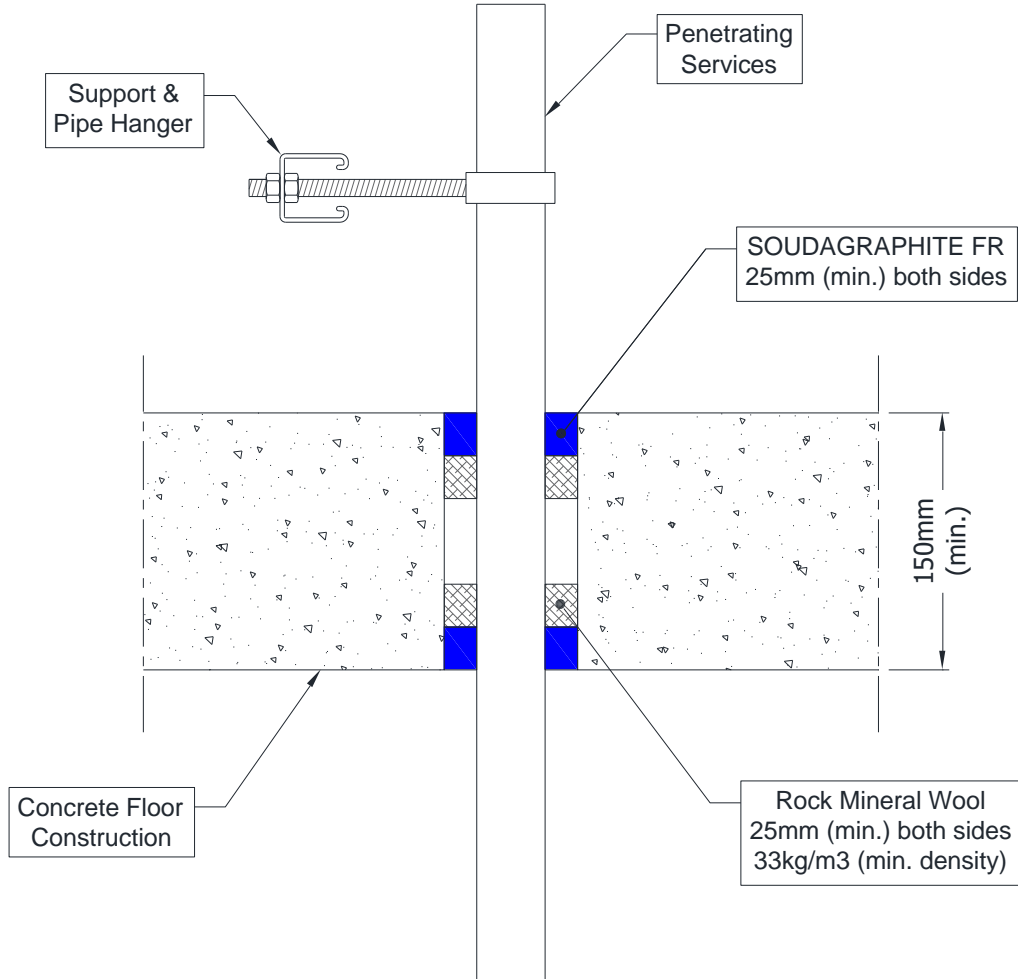

Configuration 1:

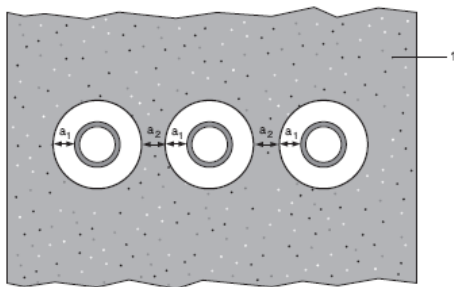

Configuration 2:

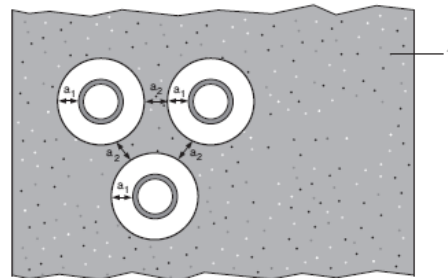

Key

- 1 Supporting construction
- a1 Pipe / edge of seal separation (annular space)
- a2 Separation between penetration seals

A.4.3.1

Services	Seal width (a1)	Permitted configuration for seal separation	Classification
PVC-U pipe according to EN 1329-1, EN 1452-2 and EN 1453-1, PVC-C according to EN 1566-1 or PP pipe according to EN 1852-1: 2009 or DIN8077/8078			
Maximum diameter 110 mm, wall thickness 1.8-6.6 mm for PVC pipes, fully or partially filled conduits with cables up to 20 mm diameter	10-30 mm	1 & 2	EI 90 U/C
Maximum diameter 110 mm, wall thickness 2.7 mm for PP pipes, fully or partially filled conduits with cables up to 20 mm diameter	10-30 mm	1 & 2	EI 90 U/C
Maximum diameter 110 mm, wall thickness 1.8-6.3 mm for PP pipes, fully or partially filled conduits with cables up to 20 mm diameter	10-30 mm	1 & 2	EI 30 U/C
PE pipe according to EN 1519-1, EN 12201-2 and EN 12006-1, ABS according to EN 1455-1 and pipes made from SAN+PVC according to EN 1565-1			
Maximum diameter 110 mm, wall thickness 2.4-10 mm, fully or partially filled conduits with cables up to 20 mm diameter	10-30 mm	1 & 2	EI 60 U/C
PP pipe according to EN 1852-1: 2009 or DIN8077/8078			
Maximum 40 mm diameter, wall thickness 1.8 mm	10-30 mm	1 & 2	EI 120 C/C
Maximum 110 mm diameter, wall thickness 1.8-6.3 mm	10-30 mm	1 & 2	EI 30 U/C

A.4.4 Penetration seals, surface mounted in concrete floors

Penetration Seal: Metallic pipes insulated with Elastomeric insulation minimum class B-s3, d0, Continuous Sustained (CS), sealed with SOUDAGRAPHITE FR, minimum 45 mm deep to both sides of the floor and backed with AES Fibre $\geq 128\text{kg/m}^3$ Wool (128kg/m^3 density), minimum 30 mm deep. Minimum separation between penetration seals of 30 mm (a2).

Construction details:

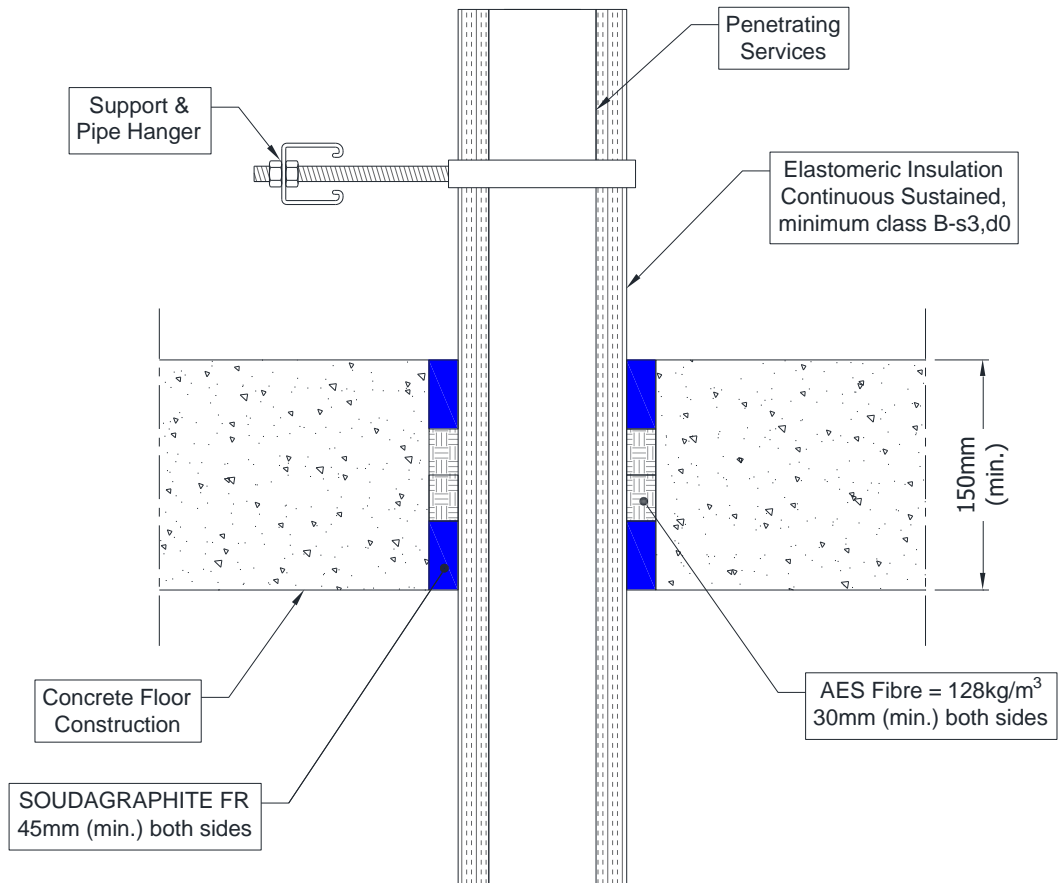

Configuration 1:

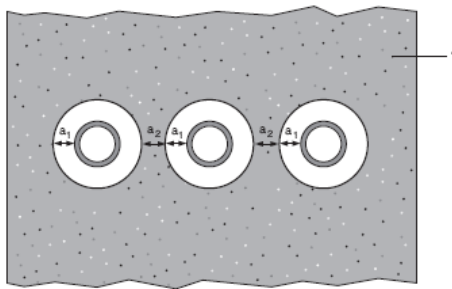

Configuration 2:

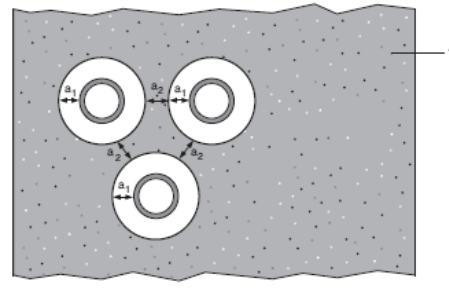

Key

- 1 Supporting construction
- a₁ Pipe / edge of seal separation (annular space)
- a₂ Separation between penetration seals

A.4.4.1

Services	Seal & backing material width (a1)	Permitted configuration for seal separation	Insulation CS	Classification
Mild or stainless steel pipe, with Elastomeric insulation minimum class B-s3, d0				
Maximum 324 mm diameter, wall thickness 1.0-14.2 mm	10-30 mm	1 & 2	25-50 mm Elastomeric insulation minimum class B-s3, d0	EI 60 C/U
Maximum 324 mm diameter, wall thickness 6.35-14.2 mm	10-30 mm	1 & 2	50 mm Elastomeric insulation minimum class B-s3, d0	EI 120 C/U

A.5 Timber floor constructions with floor thickness of minimum 150 mm

A.5.1 Pipe penetration seals, in timber floors

Penetration Seal: Metallic pipes insulated with Elastomeric insulation minimum class D-s3,d0, Continuous Sustained (CS), sealed with SOUDAGRAPHITE FR, minimum 25 mm deep to both sides of the floor and backed with Stonewool (minimum 33kg/m³ density), minimum 25 mm deep. Minimum separation between penetration seals of 0 mm (a2).

Construction details:

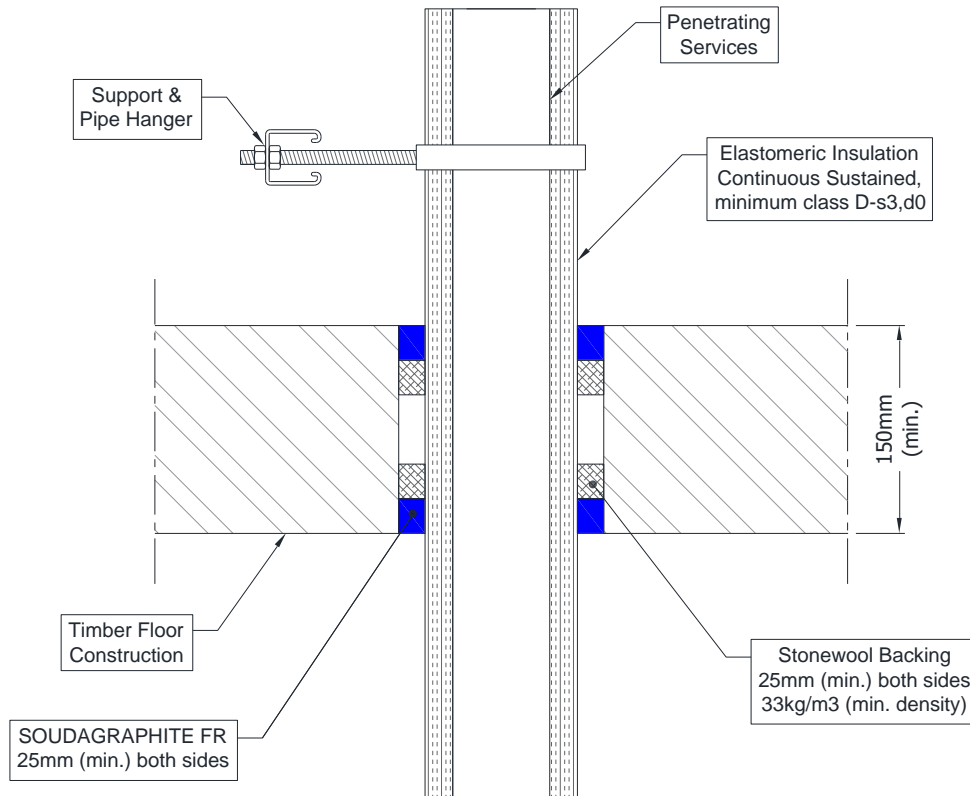

Configuration 1:

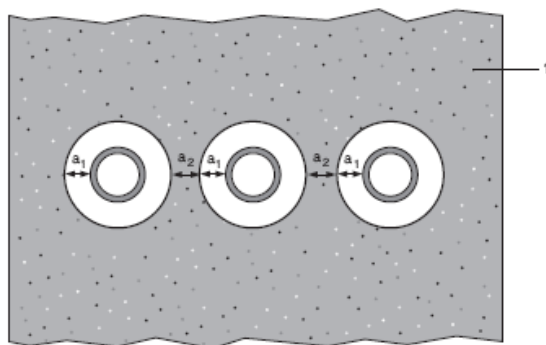

Configuration 2:

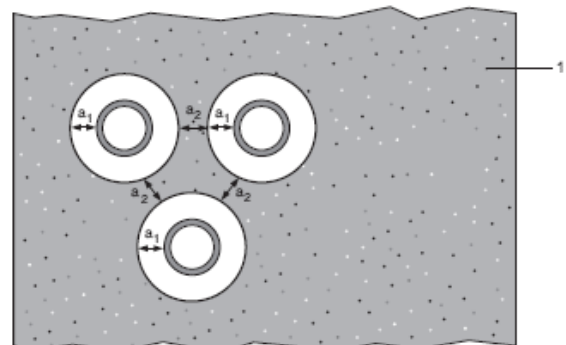

Key

1 Supporting construction

a₁ Pipe / edge of seal separation (annular space)

a₂ Separation between penetration seals

A.5.1.1

Services	Seal & backing material width (a1)	Permitted configuration for seal separation	Insulation CS	Classification
Copper, mild or stainless steel pipe				
Diameter 12 mm, wall thickness 0.7	10 mm	1	9 mm Elastomeric insulation minimum class D-s3, d0	EI 120 C/C
Diameter 12-54 mm, wall thickness*				E 120 C/C, EI 45 C/C
Diameter 12-54 mm, wall thickness*			10-25 mm Elastomeric insulation minimum class D-s3, d0	E 120 C/C, EI 30 C/C
Mild or stainless steel pipe, with Elastomeric insulation minimum class D-s3, d0				
Diameter 12-114 mm, wall thickness*	10 mm	1	9-24 mm Elastomeric insulation minimum class D-s3, d0	E 120 C/C, EI 45 C/C
Diameter 12-114 mm, wall thickness*			25 mm Elastomeric insulation minimum class D-s3, d0	E 120 C/C, EI 60 C/C
Diameter 114 mm, wall thickness 1.5-14.2			9-25 mm Elastomeric insulation minimum class D-s3, d0	E 120 C/U, EI 45 C/U
Diameter 114 mm, wall thickness 1.5-14.2			25 mm Elastomeric insulation minimum class D-s3, d0	E 120 C/U, EI 60 C/U
Alupex pipe, with Elastomeric insulation minimum class D-s3, d0				
Diameter 16 mm, wall thickness 2.25	10 mm	1	9 mm Elastomeric insulation minimum class D-s3, d0	EI 120 C/C
Diameter 16-75 mm, wall thickness*			9-24 mm Elastomeric insulation minimum class D-s3, d0	E 120 C/C, EI 60 C/C
Diameter 16-75 mm, wall thickness*			25 mm Elastomeric insulation minimum class D-s3, d0	E 120 C/C, EI 90 C/C

*See below graph for interpolation pipe sizes

Copper or Steel Pipes with Elastomeric Insulation - C/C

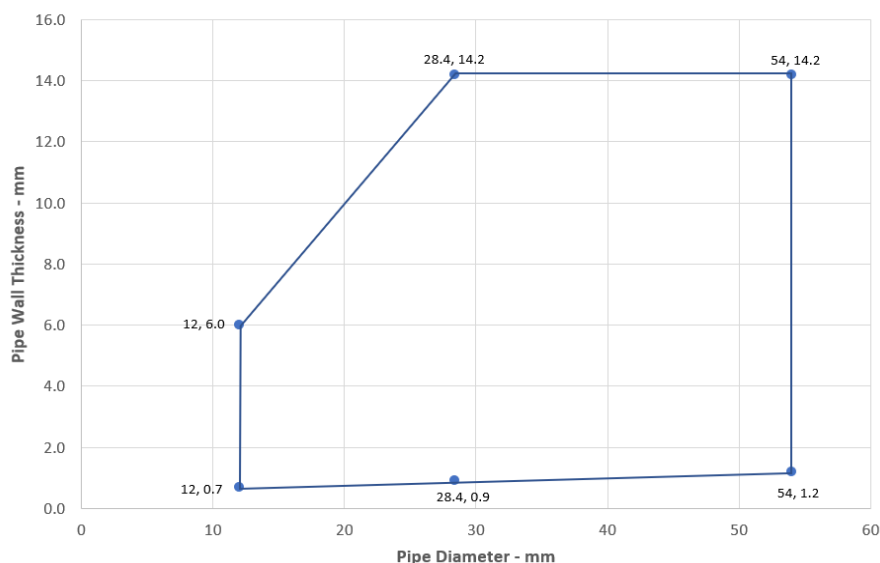

Steel Pipes with Elastomeric Insulation - C/C

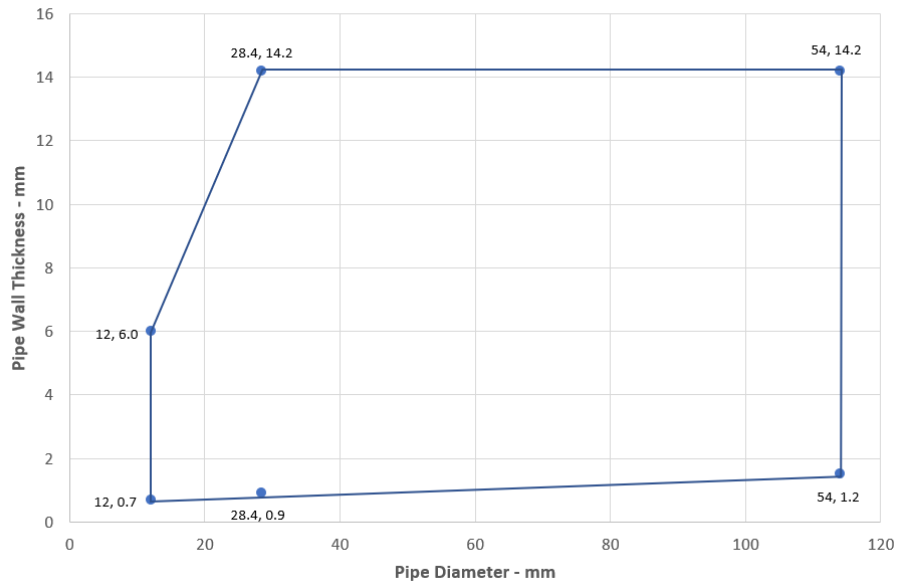

Alupex Pipes with Elastomeric Insulation - C/C

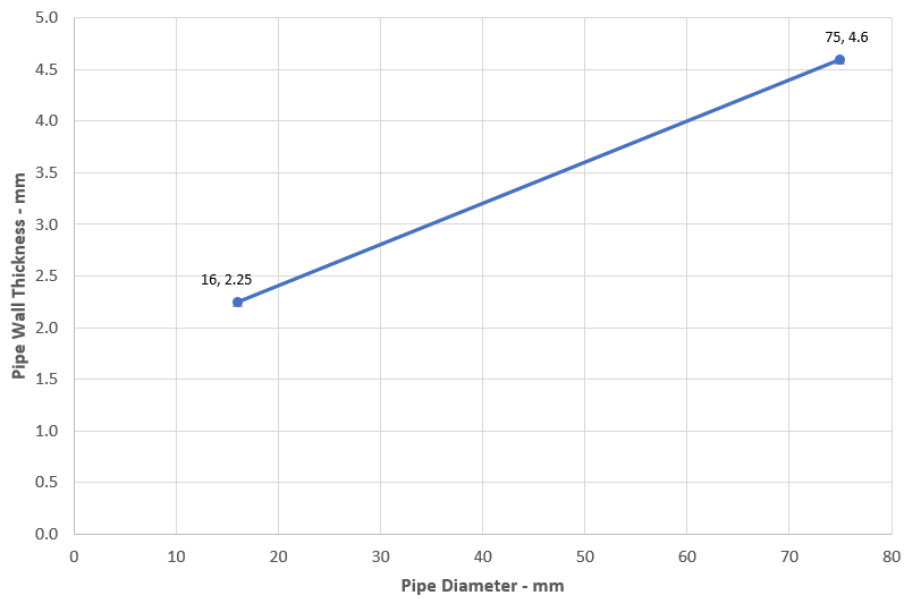

ANNEX B – Air Permeability – SOUDAGRAPHITE FR

Product tested	25mm deep x 30mm wide SOUDAGRAPHITE FR		
	Summary of testing procedure		Result
	Pressure (Pa)	Leakage (m ³ /h)	Leakage (m ³ /m ² /h)
Results under negative chamber pressure	25	0.00	0.00
	50	0.00	0.00
	100	0.00	0.00
	200	0.00	0.00
	300	0.02	0.56
	450	0.06	1.67
	600	0.12	3.33
Results under positive chamber pressure	25	0.00	0.00
	50	0.00	0.00
	100	0.00	0.00
	200	0.00	0.00
	300	0.00	0.00
	450	0.03	0.83
	600	0.13	3.61

